

2219 series

Electric Beauty Beds

Welcome to use our Electric Beauty Beds.A1
Please read the user manual carefully before using the beds.

1、About This Manual

This manual shall only be used for the reference of operation of this particular model. If the manual is used for other purposes, SILVERFOX will not undertake any according consequences and responsibility. All information of this manual shall be protected by copyright and shall not be copied and translated in any part of this specification without the written consent of our company SILVERFOX.

2、Warning

- Power supply must be cut off when changing electrical components or maintaining and cleaning machines.
- The plug must be plugged into an outlet that is properly installed and grounded, to prevent the risk of fire and electric shock.
- Do not stand on this equipment.
- Do not allow children to play with and place the equipment in a place where children can touch. Please adjust the backrest to the highest position when you leave.
- Please do not place the equipment in wet places such as bathroom to avoid electric shock or other failure; Also keep the controllers away from water.
- Please do not place and operate the equipment in places where is painting/coating or supplying oxygen.
- Unless being monitored or instructed by personnel who can be responsible for their personal safety, the people who have physical obstacles, tactile disorders, mental disorders, lack of experience, common sense or children, are not allowed to use the equipment.
- Please contact distributor, service center or related personal with appropriate skill and experience for repairing if the plug is damaged, in case of any danger.
- Please make sure there is no accessible thing within the stroke during any operation of the beds.
- Operation should be processed by trained professionals.

3、Precautions

- The equipment should be used by an experienced person who must be familiar with the product structure, performance and instructions. And make the regular maintenance work.
- Read this manual carefully before installation, operation and adjustment. And please keep it well.
- This product shall not be used for single side or single point loading work.
- Comply with safety operation rules, do not overload the use of products, to ensure that the product safety protection equipment is complete and reliable, eliminates unsafe factors on time.
- Tighten bolts and nuts regularly to avoid failure caused by loose, sliding, vibration and falling parts.
- During the maintenance, the operator shall not disassemble any parts of the bed at will.
- This product is not allowed to operate when it's with fault. If abnormal phenomenon or abnormal sound is found, it must be stopped for inspection immediately, and work can be resumed after troubleshooting.
- The operator must be familiar with the precautions described in each section of the manual to ensure the safety of person and product.
- This electric beauty bed is equipped with a three-wire power cord. The power cord must be plugged into a three-hole outlet which is properly installed and grounded. This is not only to prevent the risk of electric shock, but also ensure bed work properly.
- Please operate the equipment strictly accordance with the warning label pasted to the products.
- While controlling the lifting of the whole bed, the button must be pressed continuously until the bed in a suitable position.
- Please pay attention that the continuous working times should be Max. 2Min. ON : 18Min. OFF, when operating the motor.
- Maintenance should be processed by trained professionals.
- After each treatment, please use neutral reagent to clear the dust, stains on leather or on wood pieces.
- When adjusting the backrest, seat cushion, footrest or lifting of the whole bed by hand controller or installed foot controller, please keep your hands, feet and head away from the position.
(Please see right picture)

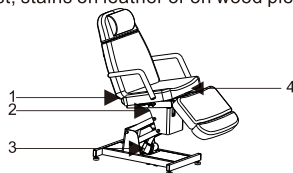

4、Applicable Range

These electric beauty beds are suitable for beauty, massage and manicure treatment.

5、Installation

1. Put the bed to a proper location, according to the overall layout, the daylighting or artificial lightings and operation condition of the salon's or the home. And keep it in the clean, dry and cool environment.
2. Open the packing carton to check if the bed is intact and whether the accessories or spares are complete. Please contact distributor or us if there's any problem.

3. Installation

Place the bed to the proper position. Please note that it is unnecessary to install extra screw on the floor to fasten the bed, because the original design has taken the stability performance into consideration. But please ensure the bed is placed on a firm and flat ground, so as to prevent any accident. If the bed rotates or slant due to rough ground, please adjust the four pieces rubber feet (M10×30) and nuts (M10) fasten on the chassis by hexagon open-end wrench, so as to ensure the bed is stable.

4. Connect the plug with power supply properly. (Details as shown below)

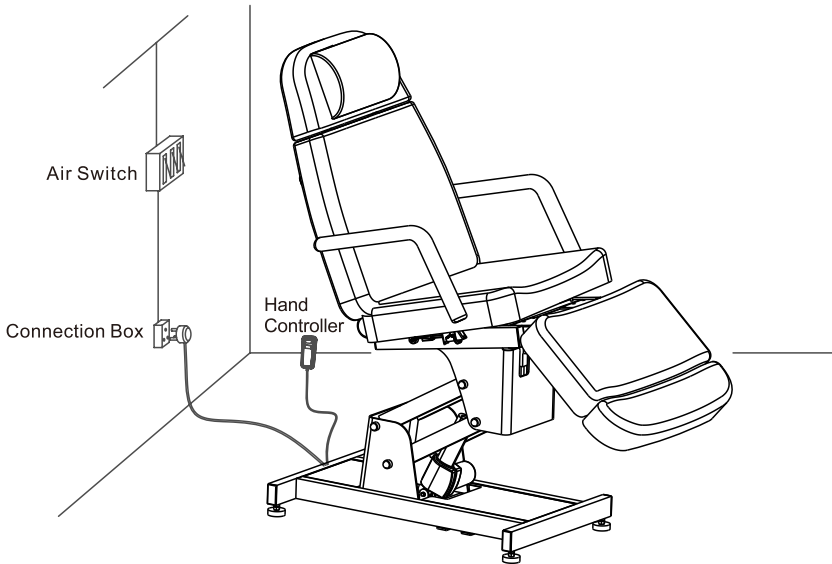

6、Structure of Electric Beauty Bed

- This beauty bed consists of control box, motor, hardware, plastic parts and leather. Among them, the control box is controlling the operation of the motors and the hand controller.
- This beauty bed includes angle adjustment of the backrest, seat cushion, footrest, and lifting adjustment of the whole bed which is an overall and integral structure.
(Details as shown below)

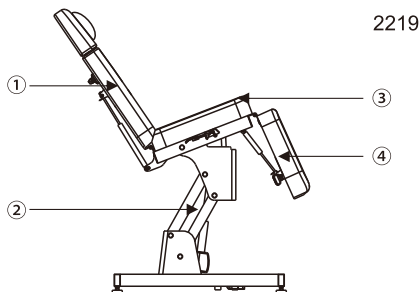

- ① angle adjustment of the backrest (manual adjustment)
 ② lifting adjustment of the whole bed
 ③ angle adjustment of the seat inclination (manual adjustment)
 ④ footrest angle adjustment (manual adjustment)

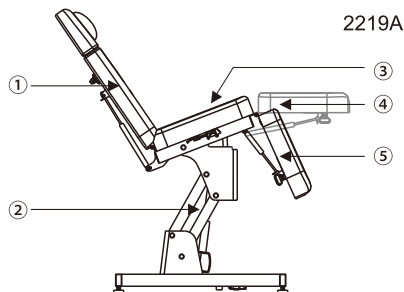

- ① angle adjustment of the backrest (manual adjustment)
 ② lifting adjustment of the whole bed
 ③ angle adjustment of the seat inclination (manual adjustment)
 ④ footrest angle adjustment (left)(manual adjustment)
 ⑤ footrest angle adjustment (right)(manual adjustment)

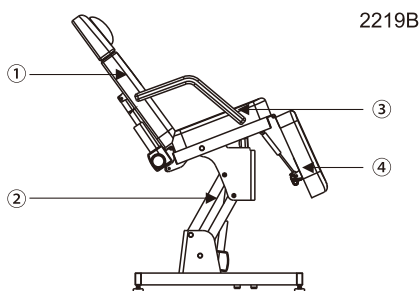

- ① angle adjustment of the backrest
 ② lifting adjustment of the whole bed
 ③ angle adjustment of the seat inclination (manual adjustment)
 ④ footrest angle adjustment (manual adjustment)

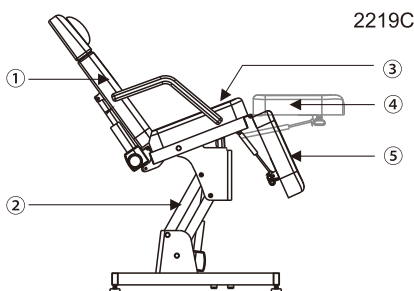

- ① angle adjustment of the backrest
 ② lifting adjustment of the whole bed
 ③ angle adjustment of the seat inclination (manual adjustment)
 ④ footrest angle adjustment (left)(manual adjustment)
 ⑤ footrest angle adjustment (right)(manual adjustment)

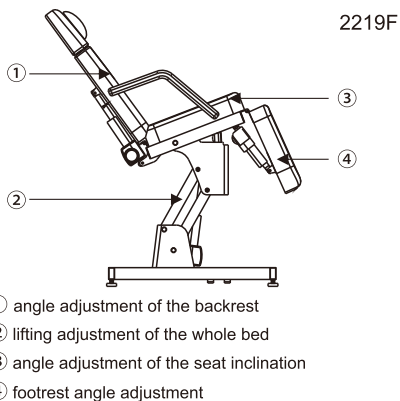
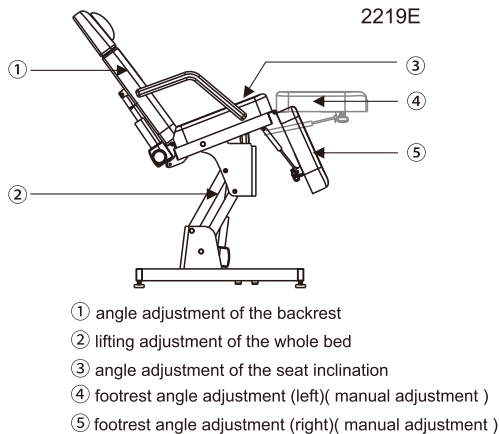
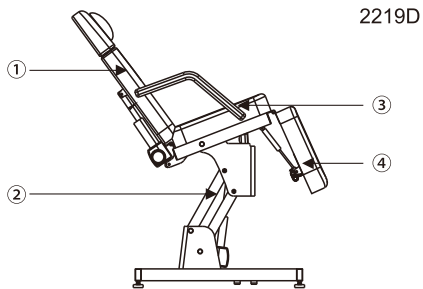

7. Operation Instruction

2219 / 2219A

1.Standard Configuration (Hand Controller)

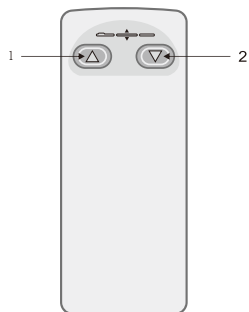

2.Optional Configuration (Foot Controller)

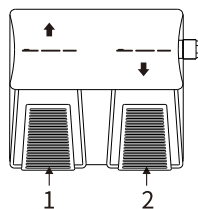

No.	Description	Operation
1	Whole bed moves up	The bed goes up smoothly by pressing the button
2	Whole bed moves down	The bed goes down smoothly by pressing the button

2219B / / 2219C

1. Standard Configuration (Hand Controller)

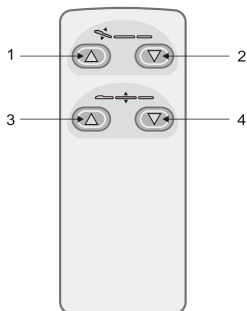

2. Optional Configuration (Foot Controller)

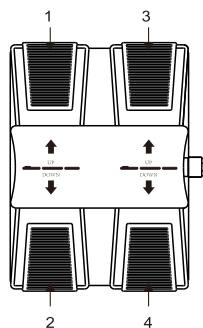

No.	Description	Operation
1	Backrest moves up	Backrest goes up smoothly by pressing the button.
2	Backrest moves down	Backrest goes down smoothly by pressing the button
3	Whole bed moves up	The bed goes up smoothly by pressing the button
4	Whole bed moves down	The bed goes down smoothly by pressing the button

2219D / 2219E

1. Standard Configuration (Hand Controller)

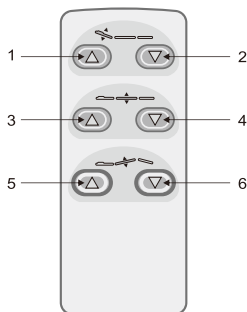

2. Optional Configuration (Hand Controller)

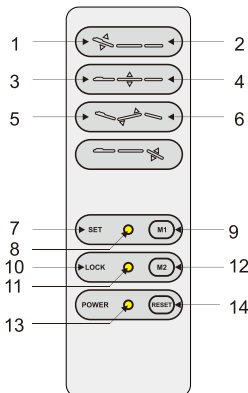

2. Optional Configuration (Foot Controller)

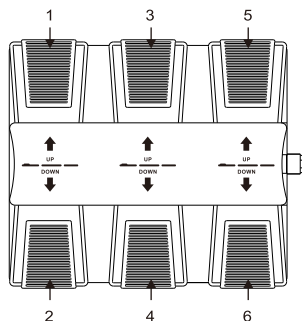

No.	Description	Operation
1	Backrest moves up	Backrest goes up smoothly by pressing the button.
2	Backrest moves down	Backrest goes down smoothly by pressing the button.
3	Whole bed moves up	The bed goes up smoothly by pressing the button.
4	Whole bed moves down	The bed goes down smoothly by pressing the button.
5	Seat cushion up	Seat inclining smoothly by pressing the button.
6	Seat cushion down	Seat goes flat smoothly by pressing the button.
7	Enter the memory position setting (Option)	The indicator light turns on after pressed the button for 2 seconds, then enter the memory position setting state.
8	Indicator light of memory setting (Option)	
9	Memory position setting 1 (Option)	<p>1. Pressing the button "SET" for 2 seconds to enter the memory position setting state, the memory position setting indicator is on. Set the position you need, and pressing the button "M1", the actions are set into memory. Exiting the memory position setting state and the indicator goes off.</p> <p>2. Press the button to move to the memory action state automatically.</p>
10	Safe-lock button	Keep pressing the "safe-lock button" for about two seconds, lighting up the green light around the button, all the buttons can not be operated except safe-lock button . Keep pressing the safe-lock button for about two seconds again, the green button lights go out, all the buttons return to normal operation status.
11	Safe-lock button light	
12	Memory position setting 2 (Option)	<p>1. Pressing the button "SET" for 2 seconds to enter the memory position setting state, the memory position setting indicator is on. Set the position you need, and pressing the button "M2", the actions are set into memory. Exiting the memory position setting state and the indicator goes off.</p> <p>2. Press the button to move to the memory action state automatically.</p>
13	Power indicator	Hand controller are connected with power supply properly, indicator light is on. Otherwise, it won't light.
14	One-key reset button	Press the button, the backrest angle will automatically move to the maximum, the seat cushion angle will automatically reduce to the minimum, footrest angle will automatically move to the maximum, the height of the bed will automatically reach the lowest position.

2219F

1. Standard Configuration (Hand Controller)

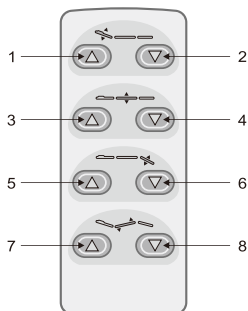

2. Optional Configuration (Foot Controller)

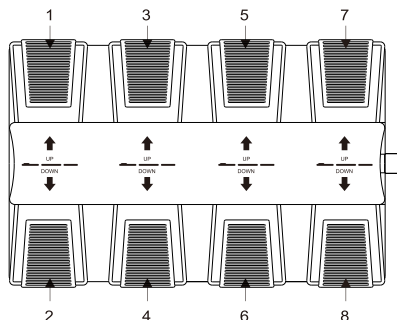

No.	Description	Operation
1	Backrest moves up	Backrest goes up smoothly by pressing the button.
2	Backrest moves down	Backrest goes down smoothly by pressing the button
3	Whole bed moves up	The bed goes up smoothly by pressing the button
4	Whole bed moves down	The bed goes down smoothly by pressing the button
5	Footrest moves up	Press the button, footrest will move up, its angle will be reduced to minimum.
6	Footrest moves down	Press the button, footrest will move down, its angle will be moved to maximum.
7	Seat cushion up	Seat inclining smoothly by pressing the button
8	Seat cushion down	Seat goes flat smoothly by pressing the button

Notes:

1. The memory position setting is only available for the models with memory function.
2. The heating function is only available for the models with heating function.
3. Different hand controllers should be chosen according to different configuration.

8、Technical Parameters

Power	AC 100-120V or AC 220-240V or AC 100-240V, 50/60Hz
Maximum Power	300W
Environment Temperature	0°C~+40°C
Relative Humidity	30%~90%
Lifting Rated Load	175 kg
Package Size	1280×690×670mm
Net Weight	60.5kg(2219) , 61kg(2219A) , 62kg(2219B) , 62.5kg(2219C) 63.5kg(2219D) , 64kg(2219E) , 65kg(2219F)
Gross Weight	73.5kg(2219) , 74kg(2219A) , 75kg(2219B) , 75.5kg(2219C) 76.5kg(2219D) , 77kg(2219E) , 78kg(2219F)

2219 / 2219B / 2219D / 2219F

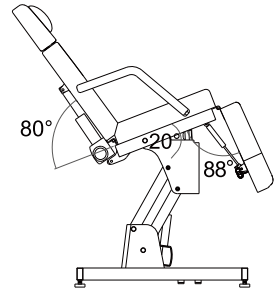
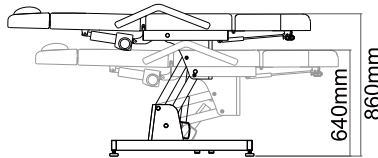
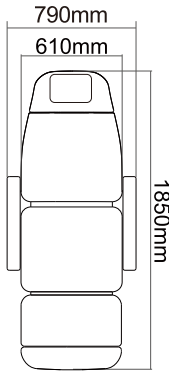

2219A / 2219C / 2219E

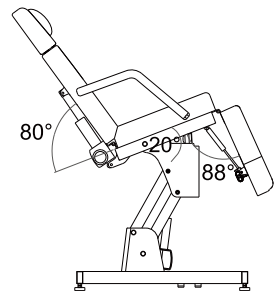
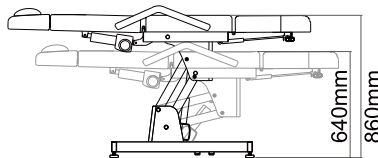
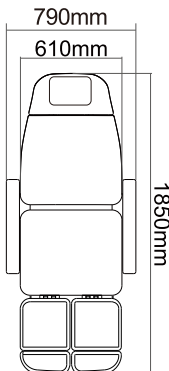

9. Maintenance

1. After every treatment, please only use neutral solution to clear the dust, stains on leather, metal part or plastic cover. Disinfecting solution like alcohol, acid or alkaline solution are forbidden. This is to prevent the lifetime of leather and plastic cover from being shorten.
2. Please lubricate the moving parts regularly (once a year).

10. Circuit System Connection Diagram

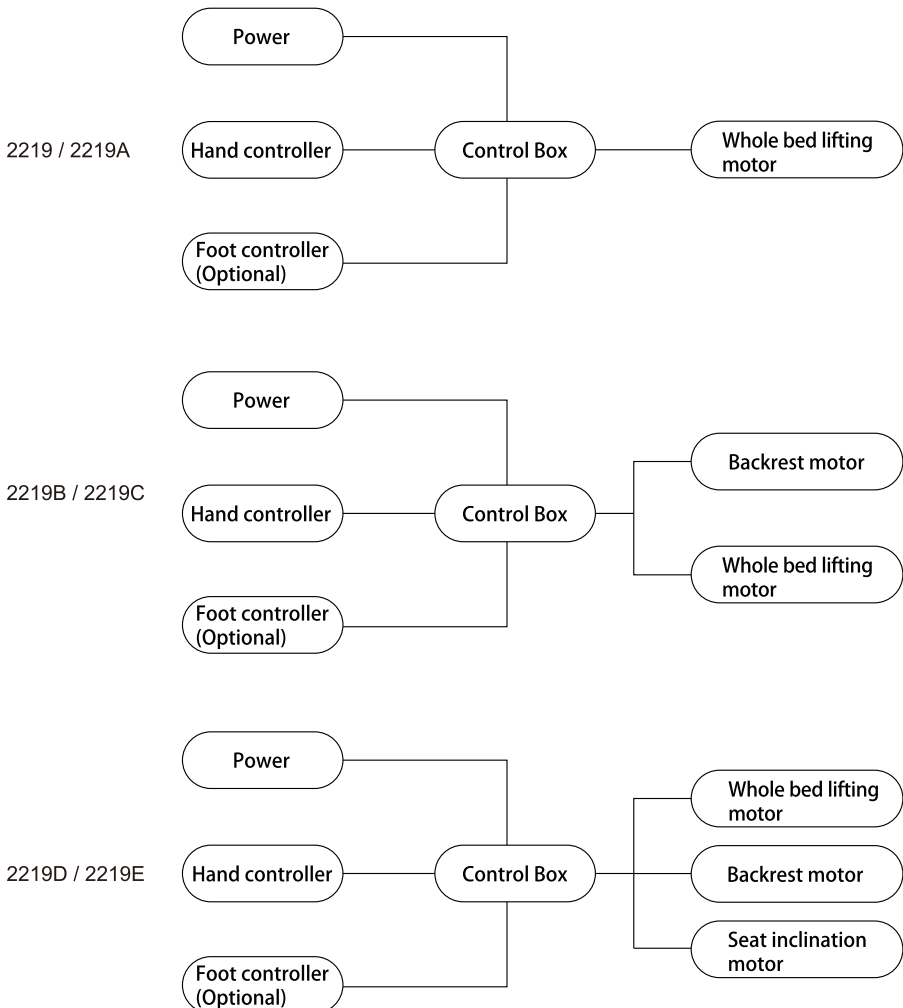

2219F

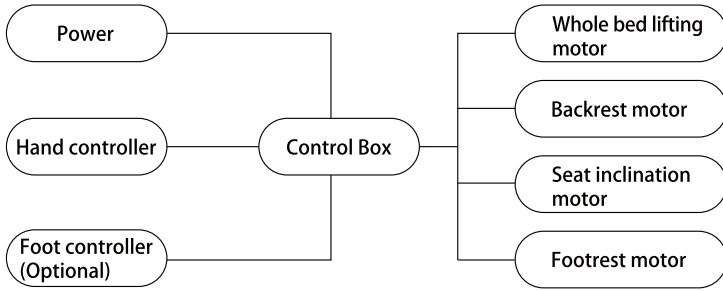

11、 Troubleshooting

The Fault Phenomenon	Reason	Solution
Can't move up or down normally	1. The power cord is unconnected or not plugged well.	1. Connect the power cord or plug it well.
	2. Poor quality of the hand controller or foot controller.	2. Replace the hand controller or foot controller.
	3. Poor quality of the control box.	3. Please contact maintenance center or supplier for troubleshooting.
	4. Repture of motor tail.	
	5. Motor was damaged.	
Abnormal Sound	1. The rotating parts are short of lubricating oil.	1. Add lubricating oil.
	2. Rotating positions (such as hinge, POM sets) are short of lubricating oil.	2. Add lubricating oil.
	3. Motor quality problems.	3. Replace the motor.

If problem is still not solved after above operations, please contact maintenance center or supplier to solve it.



Do not dispose of old or defective appliances in domestic garbage; this should only be done through public collection points.

▲ Please check the product specification before use. This manual is for reference only. Specifications are subject to change without prior notice.